



MIS 3504

Digital Design and Innovation

Entities and Data Elements

Stephen Salvia

Photo: Installation by Jenny Holzer, US Pavillion, Venice Biennale 1990

DATA

Understanding **DATA**
needed in a
business context

What is **DATA**



Core Requirement Components

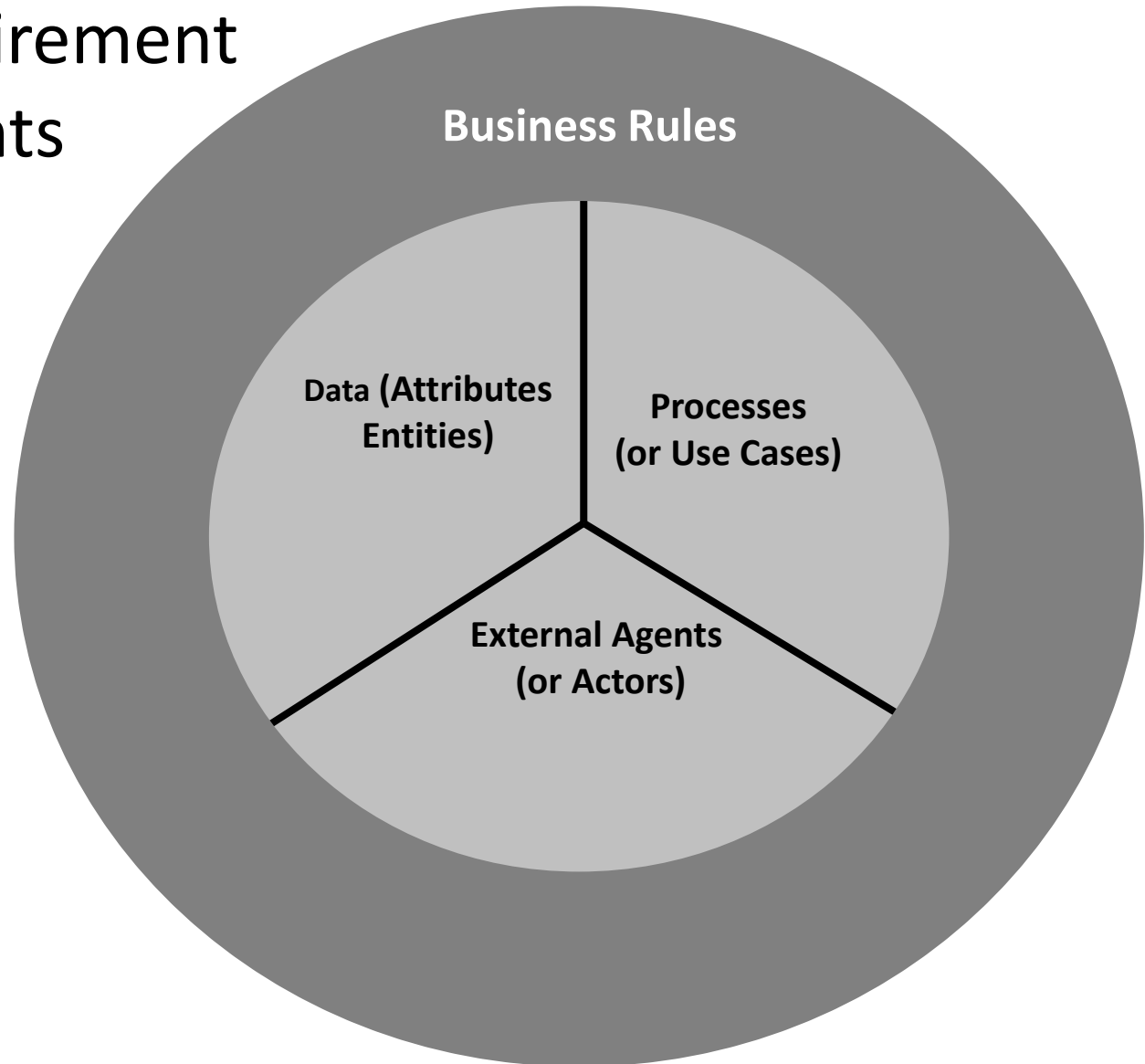

data:

1: factual information (as measurements or statistics) **used as a basis for reasoning, discussion, or calculation** <the *data* is plentiful and easily available — H. A. Gleason, Jr.>
<comprehensive *data* on economic growth have been published — N. H. Jacoby>

2: information output by a sensing device or organ that includes both useful and irrelevant or redundant information and **must be processed to be meaningful**

3: information in numerical form that can be **digitally transmitted or processed**

from <http://www.merriam-webster.com/dictionary/data>

How can data be used

Defining Data

Once you have good definitions of key terms involved in your project you are done with data. Right?

No, a common definition doesn't provide details about attributes or relationships that are important to your application

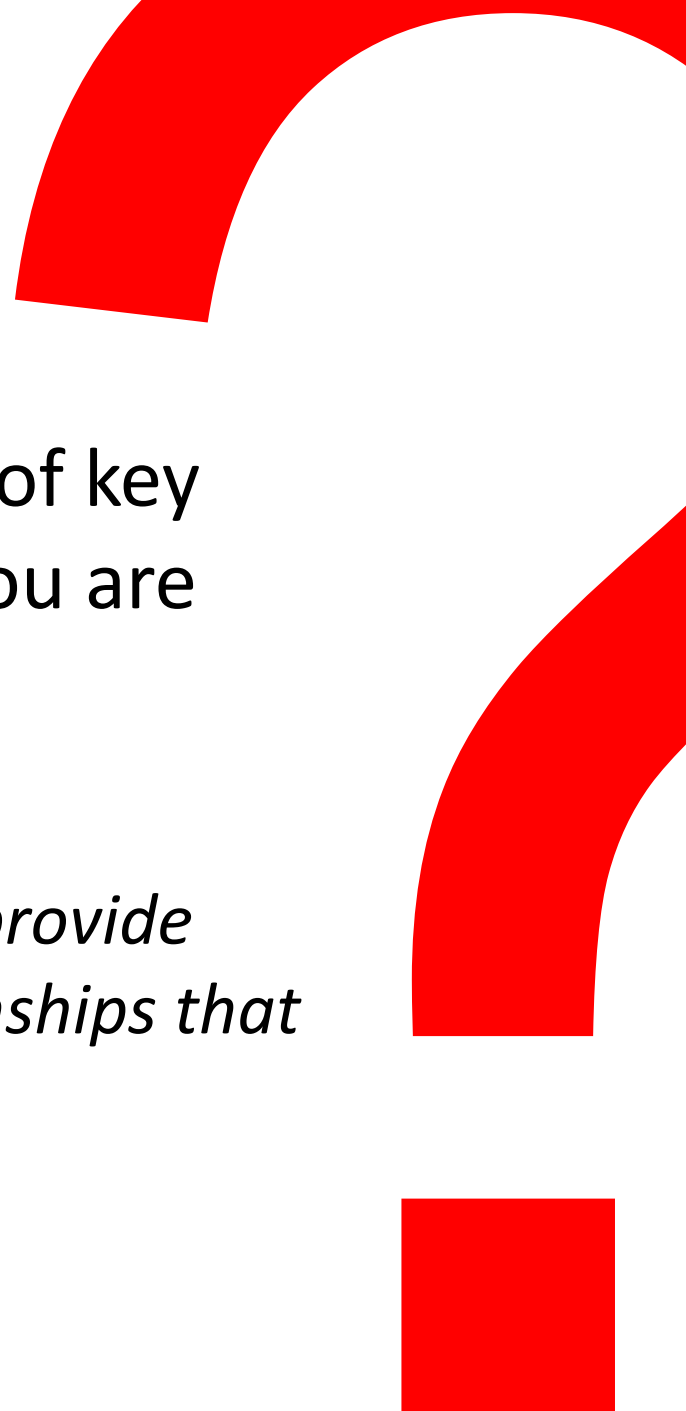

Defining Data

What other information might you want about your data?

unique identifier, owner, data types, valid values, relationships, etc.

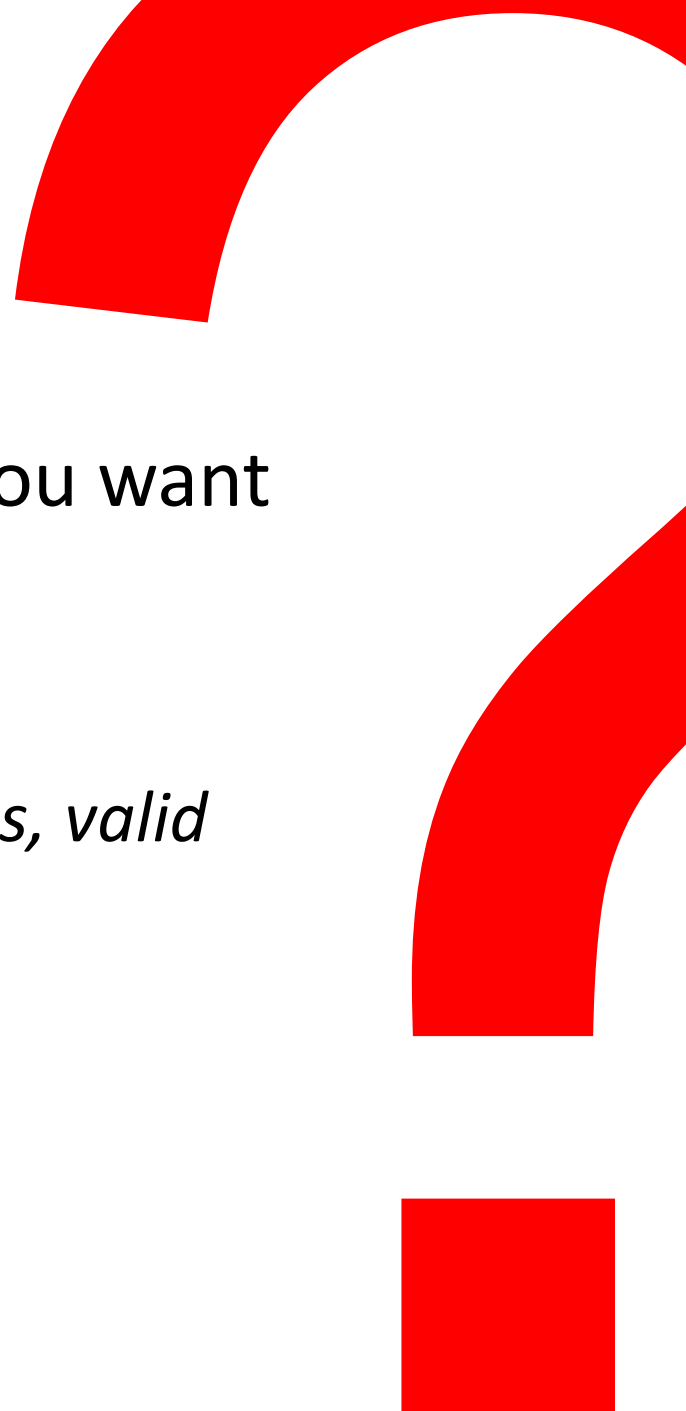

Defining Data

Logical vs. Physical

*Business structure and actual structure
User view/database view.*

One is more technical than the other and therefore can be much more confusing to a non-IT person. Get the details right on the business version, let the tech team design the database



Steps to Defining Data

- Create a **Glossary** (list) of items that have been identified during requirements gathering and interviews
- From the glossary identify the **Entities**, *not all items in the list are considered to be entities.*
- Fill in the key **Attributes** (data elements) of the entities, *these may be on the glossary list as well*
- Identify **Relationship** between the entities, *they typically represent business rules*

Entities

- **What is an entity?**

*It is a data object that has at least one attribute (type) and is manipulated by a system.
Simple/complex created/stored/transmitted, etc.*

- **Where would you look for them?**

Each entry in your glossary is a likely entity, although some may be attributes of another entity.

- **What might you want to know about them?**

Name, unique identifier, owner, relationships, etc.

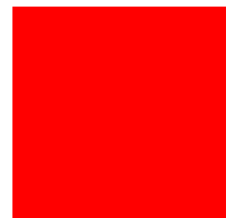

Attributes

- What is an attribute?

Further information about a data entity

- Where would you look for them?

May be in the glossary but more likely need to ask SME's about properties or characteristics of an entity

- What might you want to know about them?

Could be anything but there are some standards – data type, length, valid values, default, owner, etc.



Relationships

- What are the real world relationships between data entities?
- Try describing them in a sentence.

A customer places an order.



Relationships (continued)

- What is the **multiplicity** of the relationship?
 - One to one
 - A Temple student has one TUID number and a TUID number identifies only one student.
 - One to many
 - A doctor sees many patients.
 - Many to many
 - A library has many publication and a publication can be in many libraries.

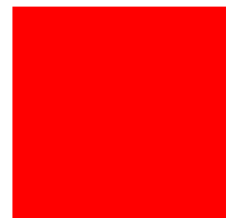

Relationships (continued)

- What is a data schema?
- What relationship notation should you use?

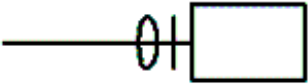
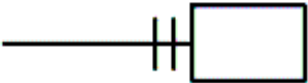
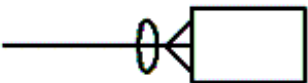
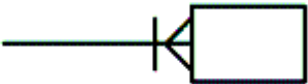
Notation	Information Engineering
<u>Multiplicities:</u>	
- Zero or one	
- One only	
- Zero or more	
- One or more	

Relationship Diagrams

Images for entity relationship

Report images

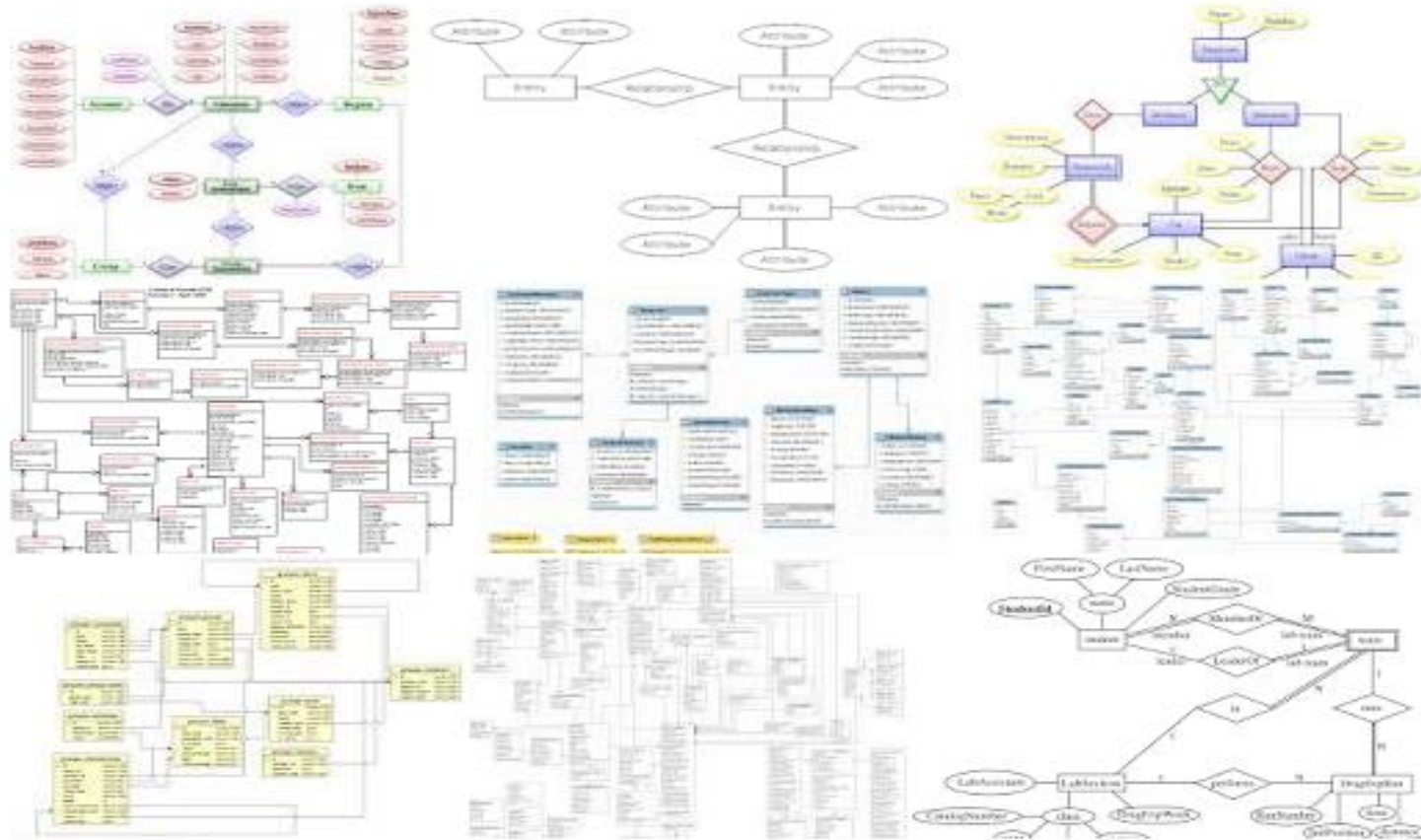

[Sample Links](#)

Asset Management Sample

(Assets are purchased from Vendors and assigned to Employees)

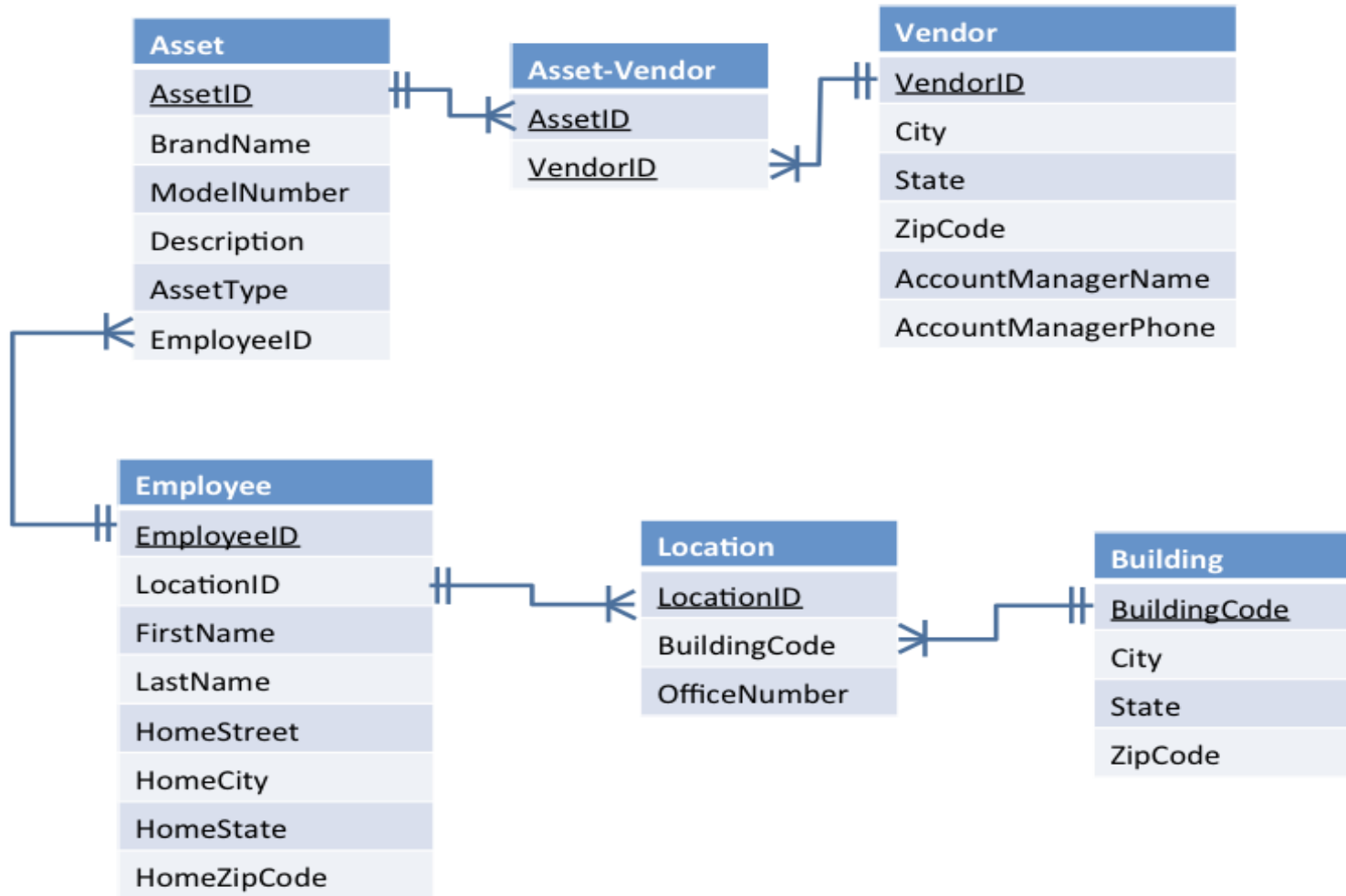

Class Challenge:

The school is interested in implementing a course enrollment solution which keeps track of the classes that a student enrolls in, the instructors that are teaching them and the resulting grades from the courses completed.

Let walk through the process

GLOSSARY: using the case, your personal experience and quick research, what are the key concepts and information needed by the Course Tracking Solution?

Write out a glossary of these terms

Glossary: Results

- Students
- Instructors
- Grades
- Sections
- Class
- Start Time
- End Time
- Start Date
- End Date
- Meeting Day

Case: (15 minutes)

ENTITIES: using your glossary, what are the entities needed for the Solution?

Write out a list of these entities.

How many do you have?

Are any related?

ENTITIES: Results

- Classes
- Instructors
- Sections
- Students
- Registrations ???

Case: (15 minutes)

ATTRIBUTES: using your list of entities, what are the attributes of each of your entities?

Write out a list of these entities.

How many do you have?

Are any related?

Entity/Attributes: Results

Classes	Instructors	Sections	Registrations	Students
Class ID	Instructor ID	Section ID	Registration ID	Student ID
Class Title	First Name	Start Date	Student ID	First Name
Category	Last Name	Start Time	Section ID	Last Name
Credits	Street	Instuctor ID	Grade	Neighborhood
Description	Apt	Fee		Street
	City	Class Id		City
	State	Live Models		State
	zip	Meeting Day		zip
	Phone			Phone
				Birth Date
				Discount

Case: (15 minutes)

Relationships: using your list of entities, what are the relationships between each of your entities?

Write a sentence to describe each relationship.

What are the multiplicities of the relationships?

Relationship: Results

- A Course can have multiple sections
- Instructors teach multiple sections
- Students register for a section
- Students get a grade for specific course section
- A class can only have one primary instructor
- Students can register for many courses
- Students can not register for two sections of the same course in the same semester

Relationship: Results

(MS Access)

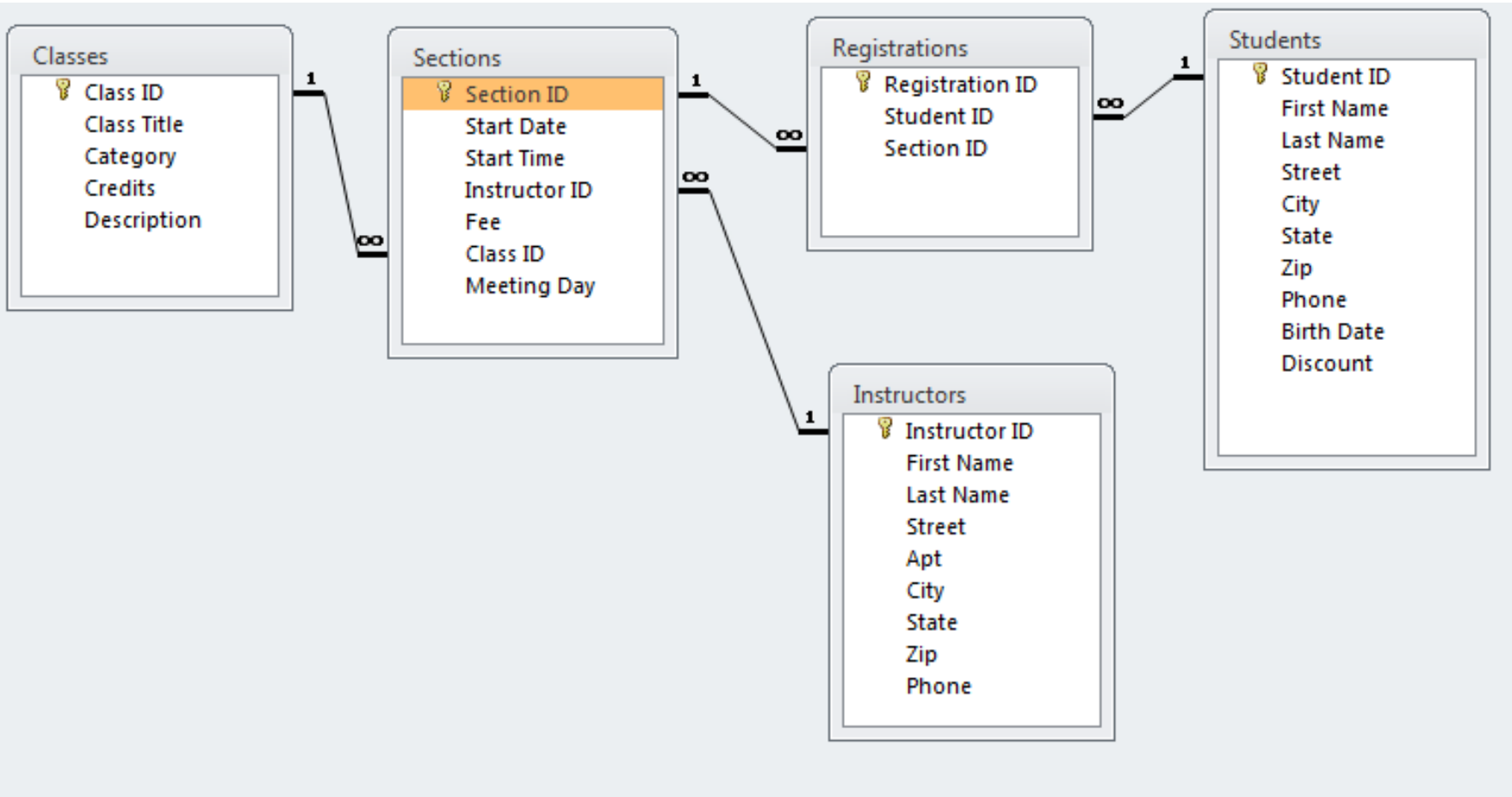

Relationship: Results

(Google Docs)

Student Class ER Diagram

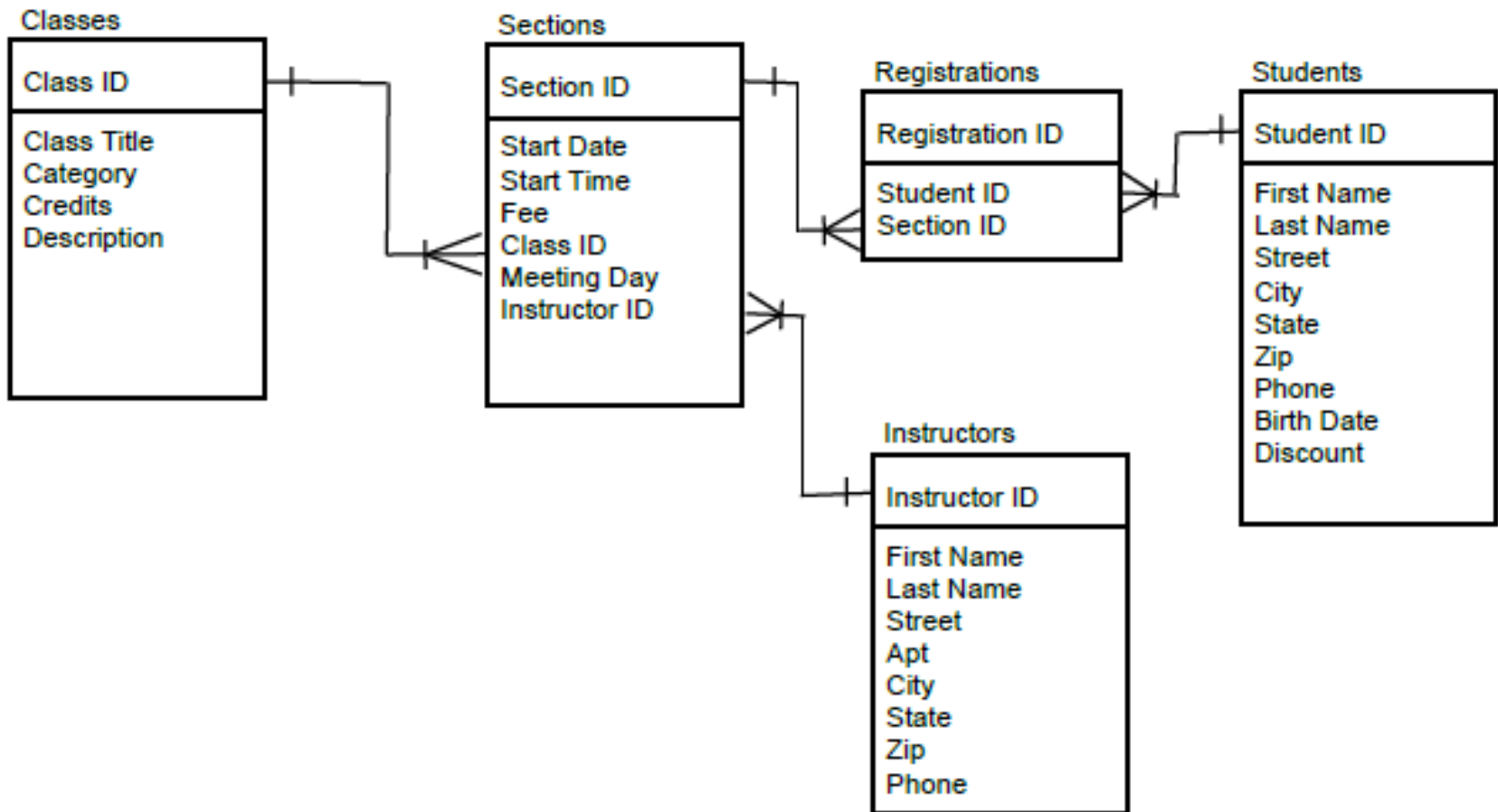

Challenge Review:

1. How did it go?
2. What does the list of entities, attributed and relationships look like?
3. What confused you?
4. What follow-up questions do you have?
5. What problems or opportunities should you be looking for?

Data Evaluation

1. How well does the schema describe the data involved in the client's problem?
2. How completely does they cover the client's situation?
3. Does it accurately reflect what data the client is using?
4. Is it an appropriate tool for the client's situation?

Individual Challenge:

Solutions-Plus Case Study
Due Class 7, February 26, 2019

[Solutions-Plus Client Project Data Analysis](#)

[ERD Blank Template Excel](#)

[Google Doc ER Template](#)

Solutions-Plus Client Project Data Analysis

Case Material

Consultants Responsibilities

- Locate Clients Information from company achieves
- Work one or more projects associated for a single Client
- Work on multiple Client projects
- Track the dates and time (hours) spent on each Client Project
- Enter Business expenses associated to client projects
- Tracking the travel bookings of Air Flights, Hotels and Rental Cars associated with each round trip

Notes on Responsibilities and how they are currently performed

Locate Clients and project codes	Send email to ask Client Relationship Manager and ask for client code and project code
Enter Time on Client and Project	Fill out a spread sheet with a row for each day, client id, project code and hours
Review Personal Time reporting	I manually tally up the totals from in my monthly spreadsheet to see how much billable work I have completed
Client Time Submission review / approval	eMail to Client Relationship Mangers , Must have it done my end of month but try to do it more often
Track my time with clients on a calendar	I will frequently log time with each client and project on my calendar as a note so I can remember where to charge my time
Enter Business expenses	All expenses are charge to our Corporate Credit cards, which we are personally responsible to pay. We fill out a separate spread sheet to get reimbursement for the expenses, information includes a scanned copy of the monthly charge bill, and information includes a scanned copy of the monthly charge bill. This information is sent to the Client Relationship Managers who approves then sends it on to the System Administrator who enter the data into the payroll system.
Book Travel on the phone (with system administrator)	Call the system Administrators to book flights, hotels and cars. We give them our Corporate Charge Card number.

Step 1:

GLOSSARY: using the case, your personal experience and quick research, what are the key concepts and information needed?

Write out a glossary of these terms

Step 2:

ENTITIES: using your glossary, what are the entities needed by to support the proposed application?

Write out a list of these entities.

How many do you have?

Are any related?

Step 3:

ATTRIBUTES: using your list of entities, what are the attributes of each of your entities?

Write out a list of these entities.

How many do you have?

Are any related?

Step 4:

Relationships: using your list of entities, what are the relationships between each of your entities?

Write a sentence to describe each relationship.

What are the multiplicities of the relationships?

Develop an ER Diagram depicting the relationships